

brand	PARTNER
-------	----------------

date	FEB/03	SHEET 1/6
------	--------	-----------

Model	Prefix
P 461 II 13" .325	01

Product number
953900232



FIGURA 1

brand	PARTNER
-------	----------------

date	FEB/03	SHEET 2/6
------	--------	-----------

Model	Prefix
P 461 II 13" .325	01

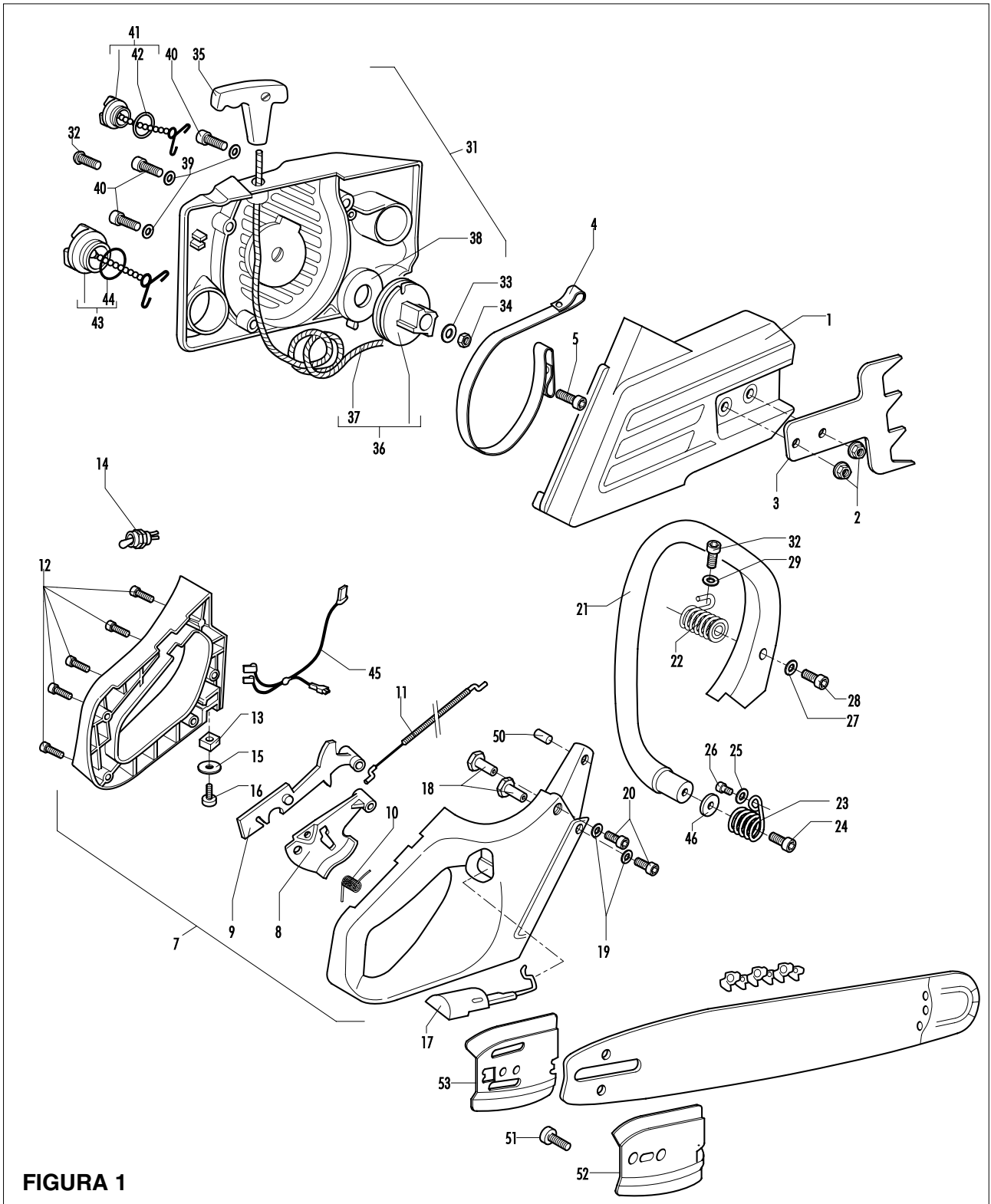
Product number
953900232

FIGURA 1

pos	P/N McC	P/N ELX	Qty	DESCRIPTION	pos	P/N McC	P/N ELX	Qty	DESCRIPTION
C 1	248439	538248439	1	CLUTCH COVER KIT	B 38 ●	235040	538235040	1	SPRING
A 2	227762	538242501	2	M8 NUT	39	235248	538235248	3	WASHER M5
C 3	241993	538241993	1	SPIKE	40	236997	538236997	3	M5X30 SCREW
B 4	235073	538235073	1	BAND BRAKE	B 41	240866	538240866	1	OIL CAP ASSY
5	235812	538235812	1	SPECIAL BRAKE SCREW	C 42 ●	235511	538235511	1	O-RING OIL CAP
C 7	240339	538240339	1	REAR HANDLE ASSY	B 43	240865	538240865	1	FUEL CAP ASSY
C 8 ●	240301	538240301	1	GAS LEVER	C 44 ●	235510	538235510	1	O-RING MIX CAP
C 9 ●	240302	538240302	1	SAFETY TRIGGER	C 45 ●	240370	538240370	1	CABLE ASSY
10 ●	240303	538240303	1	MOLLA LEVA GAS	46	236934	538236934	1	WASHER
C 11 ●	240367	538240367	1	WIRE ASSY	50	240323	538240323	1	SPACER
12 ●	240862	538240862	5	SCREW 4X18	51 ●	228554	538228554	1	M 2,9X6,5 SCREW
13	229524	538229524	1	NUT M5	C 52 ●	241915	538241915	1	BAR PLATE (OUT)
C 14	240859	538240859	1	SWITCH ON_OFF	C 53	241914	538241914	1	BAR PLATE (IN)
15	227259	538227259	1	WASHER					
16	240845	538240845	1	SCREW					
C 17	247259	538247259	1	ROD CHOK ASSY					
18	240315	538240315	2	NUT					
19	235248	538235248	2	WASHER M5					
20	235802	538235802	2	SCREW M5 X 14 TCE					
21	240281	538240281	1	FRONT HANDLE					
B 22	241231	538241231	1	UPPER AV SPRING ASSY					
B 22	240289	538240289	1	SPRING					
B 23	240285	538240285	1	SPRING					
24	240354	538240354	1	SCREW 6X30					
25	235248	538235248	1	WASHER M5					
26	235802	538235802	1	SCREW M5 X 14 TCE					
27	235248	538235248	1	WASHER M5					
28	235803	538235803	1	SCREW M5 X 25 TCE					
29	227259	538227259	1	WASHER					
30	235802	538235802	1	SCREW M5 X 14 TCE					
C 31	241854	538241854	1	STARTER ASSY					
32 ●	240316	538240316	1	SCREW M5X35					
33 ●	240921	538240921	1	WASHER					
34 ●	229208	538229208	1	NUT M5					
35 ●	240884	538240884	1	STARTER-HANDLE					
B 36 ●	235372	538235372	1	DRUM AND ROPE					
A 37 ●●	235042	538235042	1	ROPE					

A= ALTA ROTAZIONE
B=MEDIA ROTAZIONE
C=BASSA ROTAZIONE

A=HIGH MOVING
B=MEDIUM MOVING
C=SLOW MOVING

A=HAUTE DEMANDE
B=MOYENNE DEMANDE
C=BASSE DEMANDE

A=GROBE NACHFRAGE
B=MITTELMAEBIGE
C=WENIGE NACHFRAGE

brand	PARTNER
-------	----------------

date	FEB/03	SHEET 3/6
------	--------	-----------

Model	Prefix
P 461 II 13" .325	01

Product number
953900232

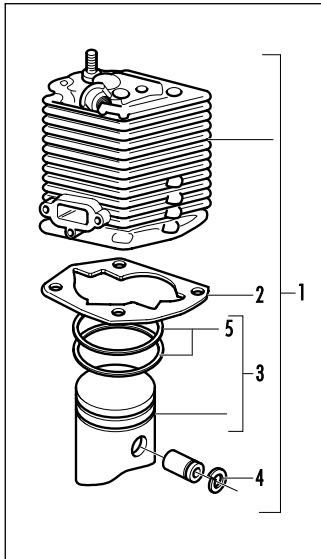

FIGURE 3

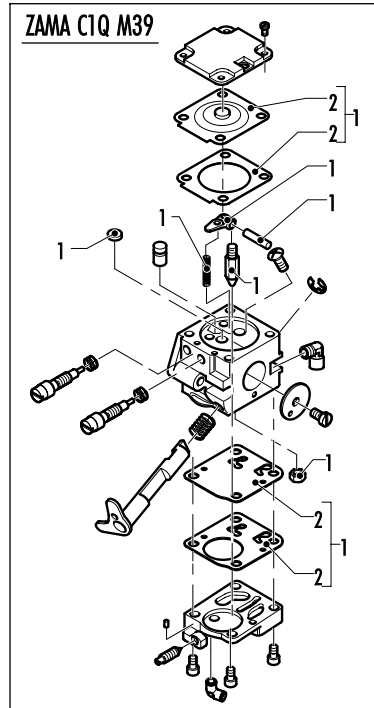

FIGURE 4

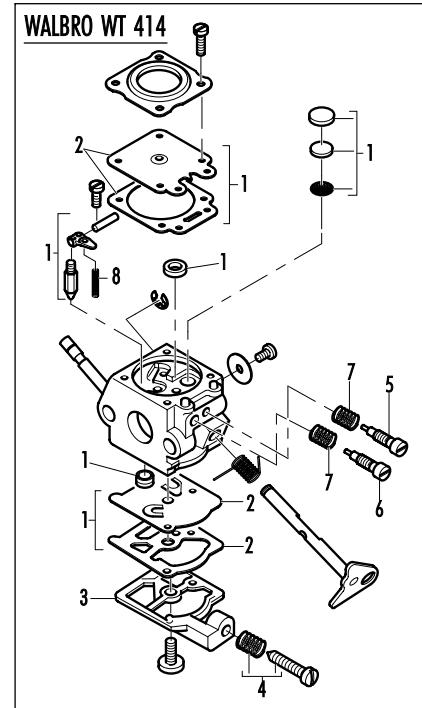

FIGURE 4



FIGURA 2

brand	PARTNER
-------	----------------

date	FEB/03	SHEET 4/6
------	--------	-----------

Model	Prefix
P 461 II 13" .325	01

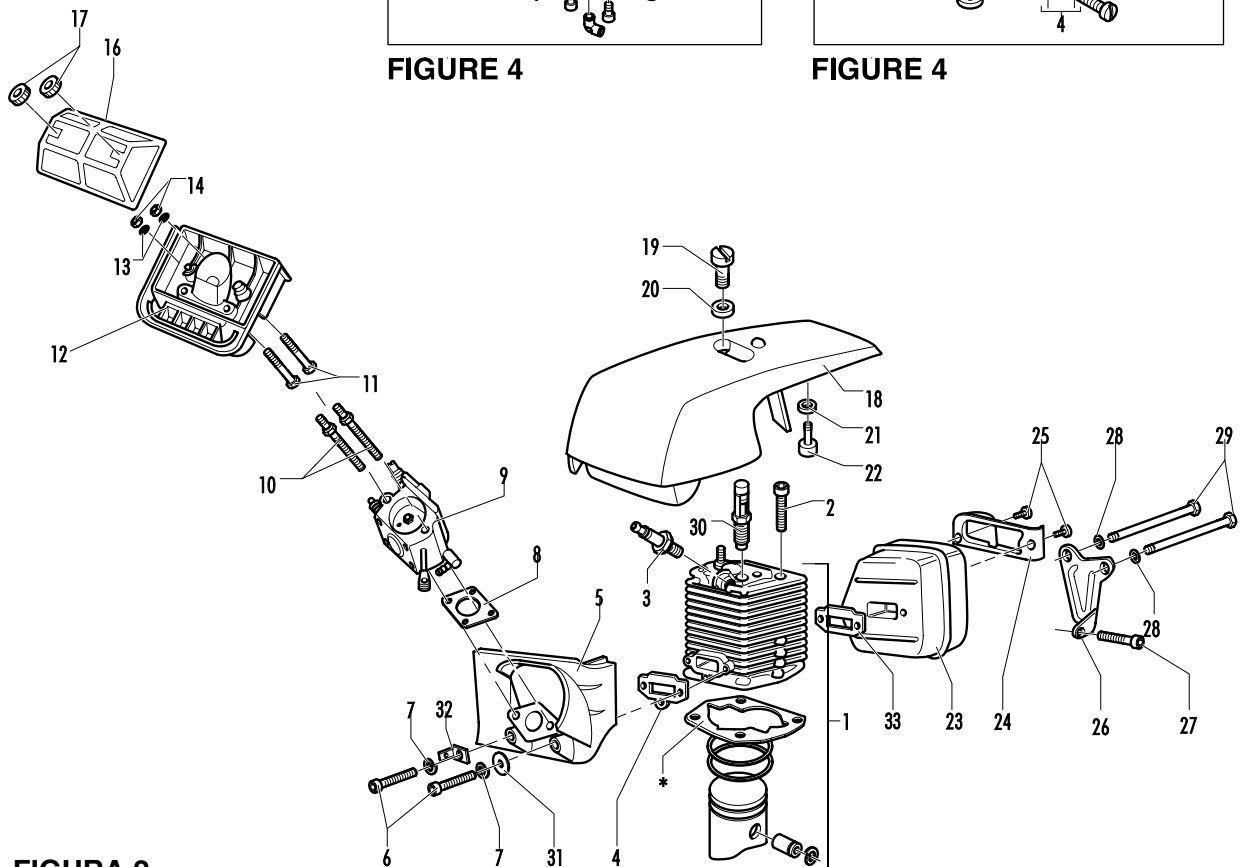
Product number
953900232

FIGURA 2

pos	P/N McC	P/N ELX	Q.ty	DESFRIPTION
C 1	FIGURA 3			
2	227565	538227565	4	SCREW M5X25
A 3	92879	538092879	1	SPARK PLUG RDJ&J
B 4	240345	538240345	1	GASKET
5	240271	538240271	1	CARBURETOR SPACER
6	236997	538236997	2	M5X30 SCREW
7	236529	538236529	2	SPLIT WASHER
A 8	227692	538227692	1	GASKET
C 9	FIGURA 4			
10	240328	538240328	2	BAR BOLT
12	240262	538240262	1	AIR FILTER BOX
13	235248	538235248	2	WASHER M5
14	235216	538235216	2	NUT M5
15	241239	538241239	2	RUBBER CAP
B 16	241238	538241238	1	AIR FILTER S5
18	242669	538242669	1	ENGINE COVER ASSY
18	242660	538242660	1	ENGINE COVER
18	241917	538241917	1	GREEN ENGINE COVER
19 ●	240320	538240320	1	SCREW
20 ●	240321	538240321	1	WASHER
21 ●	236936	538236936	1	WASHER
22 ●	240272	538240272	1	FAN BAFFLE
23	240291	538240291	1	MUFFLER
24 ●	240297	538240297	1	PROMAC MUFFLER BAFFLE
25 ●	236981	538236981	2	T5 SCREW
26	240299	538240299	1	SUPPORT MUFFLER
27	236997	538236997	1	M5X30 SCREW
28	227626	538227626	2	WASHER D-5
29	227567	538227567	2	SCREW M5X70
30	94273	538094273	1	VALVE COMPRELEASE
31	235248	538235248	1	WASHER M5
32	228139	538228139	1	CONTACT WIRE
C 33	240344	538240344	1	MUFFLER GASKET

FIGURA 3

pos	P/N McC	P/N ELX	Q.ty	DESCRIPTION
		38 cc		
C 1	247253	538247253	1	38cc CYLINDER KIT
B 2 ●	240343	538240343	1	GASKET
C 3 ●	247256	538247256	1	46cc PISTON KIT
4 ●●	235008	538235008	2	RING SNAP INT.
B 5 ●●	240005	538240005	2	PISTON RING (1PC)
		42 cc		
C 1	248806	538248806	1	CYL/PIST.KIT 42cc
B 2 ●	242366	538242366	1	GASKET
C 3 ●	248807	538248807	1	PISTON KIT 42cc
4 ●●	229544	538229544	2	RETAINING RING
B 5 ●●	240085	538240085	1	40cc PISTON RING
		46 cc		
C 1	248500	538248500	1	CYL/PIST.KIT PM46 II
B 2 ●	240343	538240343	1	GASKET
C 3 ●	247258	538247258	1	46cc PISTON KIT
4 ●●	229544	538229544	2	RETAINING RING
B 5 ●●	240353	538240353	1	46cc PISTON RING

FIGURA 4

WALBRO WT 414				
C -	240350	538240350	1	CARBURATOR WT 414
B 1 ●	247260	538247260	1	MAIN KIT CARB.K20 WAT
A 2 ●●	229191	538229191	1	GASKET-DIAPH.W
3 ●	247261	538247261	1	PUMP COVER
4 ●	237481	538237481	1	IDLE SCREW KIT
5 ●	247388	538247388	1	HI SCREW CARB.WT 414
6 ●	246540	538246540	1	HIGH SPEED NEEDLE
7 ●	229601	538229601	2	NEEDLES SPRING
C 8 ●	247387	538247387	1	98-3249 SPRING
ZAMA C1Q M39				
C -	242062	538242062	1	AIR FILTER BOX
B 1 ●	226226	538226226	1	KIT REPAIR CARB.C1Q
A 2 ●●	226227	538226227	1	KIT GASKET+DIAPH C1Q

A= ALTA ROTAZIONE
B=MEDIA ROTAZIONE
C=BASSA ROTAZIONE

A=HIGH MOVING
B=MEDIUM MOVING
C=SLOW MOVING

A=HAUTE DEMANDE
B=MOYENNE DEMANDE
C=BASSE DEMANDE

A=GROBE NACHFRAGE
B=MITTELMAEBIGE
C=WENIGE NACHFRAGE

brand	PARTNER
-------	----------------

date	FEB/03	SHEET 5/6
------	--------	-----------

Model	Prefix
P 461 II 13" .325	01

Product number
953900232



FIGURA 5

brand	PARTNER
-------	----------------

date	FEB/03	SHEET 6/6
------	--------	-----------

Model	Prefix
P 461 II 13" .325	01

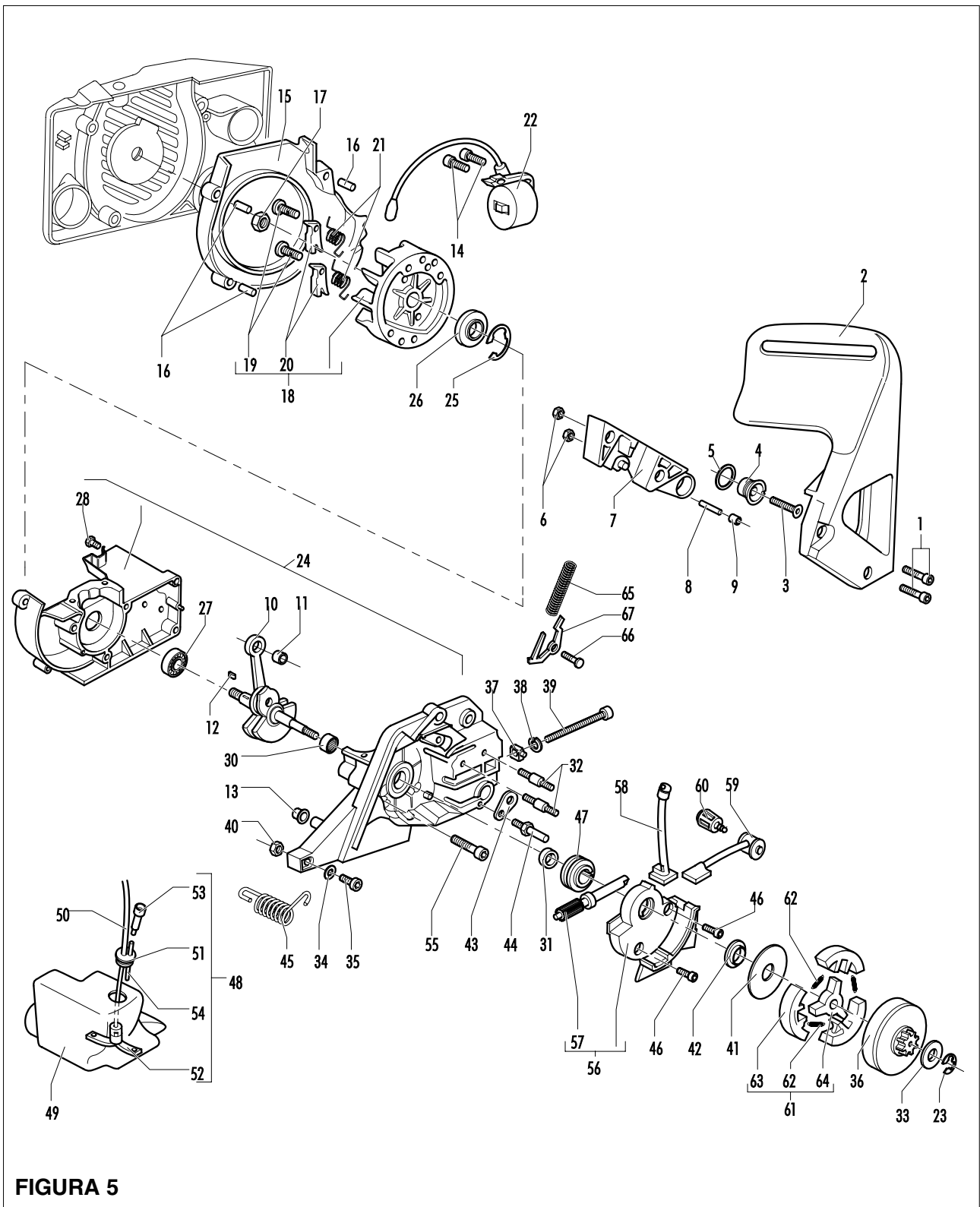
Product number
953900232

FIGURA 5

pos	P/N McC	P/N ELX	Q.ty	DESCRIPTION	pos	P/N McC	P/N ELX	Q.ty	DESCRIPTION
1	235806	538235806	2	SCREW M5 X 20 TCE	B 36	240260	538240260	1	DRUM SPROCKET 3/8
C 2	241907	538241907	1	BRAKE LEVER	B 36	240266	538240266	1	DRUM SPROCKET 325
3	241905	538241905	1	SCREW M6X25	B 37	241908	538241908	1	NUT BAR ADJUSTEMENT
4	241904	538241904	1	SLEEVE	B 38	235367	538235367	1	BENZING 4MM
5	241906	538241906	1	PLAN WASHER D.10X15X1	B 39	241909	538241909	1	SCREW
6	235642	538235642	2	NUT M5	40	235642	538235642	1	NUT M5
7	241902	538241902	1	BRAKE HOUSING	41	241346	538241346	1	WASHER
8	242017	538242017	1	BAND PIVOT	42	242006	538242006	1	CLUTCH SPACER
9	241903	538241903	1	BRAKE NEEDLE	43	240309	538240309	1	PLATE OIL CAP
10	241871	538241871	1	CRANKSHAFT ASSY	C 44	240363	538240363	1	CHAIN BRAKE
10	241873	538241873	1	CRANKSHAFT ASSY	B 45	240286	538240286	1	SPRING
C 11	● 235742	538235742	1	9X14X12 MM NEEDLE BEARING	46	235802	538235802	2	SCREW M5 X 14 TCE
C 11	227329	538227329	1	12X15X13 NEEDLE BEARING	C 47	241882	538241882	1	OIL PUMP SCREW
12	227631	538227631	1	KEY	48	240920	538240920	1	FUEL TANK ASSY
13	235672	538235672	1	RUBBER SUPPORT TANK	49	● 240300	538240300	1	FUEL TANK
14	235806	538235806	2	SCREW M5 X 20 TCE	B 50	● 240868	538240868	1	HOSE FUEL
15	247290	538247290	1	AIR CONVEYOR	C 51	● 235675	538235675	1	FUELTANK GROMMET
16	● 240358	538240358	3	SPACER	A 52	● 240452	538240452	1	PICK UP FUEL
17	235218	538235218	1	NUT M8	C 53	● 227582	538227582	1	VENT FILTER
18	241204	538241204	1	FLYWHEEL KEY=2 S7	54	● 229716	538229716	1	BREATHER PIPE OIL TANK
B 19	● 235516	538235516	2	STARTER PIN PAWL	55	236997	538236997	4	M5X30 SCREW
B 20	● 235517	538235517	2	STARTER PAWL	B 56	241883	538241883	1	OIL PUMP ASSY
B 21	● 235518	538235518	2	STARTER SPRING	C 57	● 241885	538241885	1	OIL PUMP PISTON KIT (S5E)
C 22	241291	538241291	1	IGNITION COIL ASSY-S5	58	● 241895	538241895	1	PIPE JOINT
23	229137	538229137	1	BENZING 8MM	59	● 241896	538241896	1	TUBE OIL PUMP
24	248497	538248497	1	L CRANKCASE KIT	C 60	225063	538225063	1	BUMPER CUT CONTROL
25	● 235899	538235899	1	SEEGER RING	61	242004	538242004	1	CLUTCH KIT
C 26	● 241879	538241879	1	SEAL 15X32X4/5	B 62	● 240926	538240926	3	SPRING
27	● 235900	538235900	1	BALL BEARING 6002 15/32/9	63	● 227359	538227359	3	SHOE-CLUTCH
28	● 241077	538241077	1	SELF-THREAD. SCREW 4X14	64	● 242005	538242005	1	ROTOR CLUCTCH
30	● 241253	538241253	1	NEEDLE BEARING 15X21X12	65	235076	538235076	1	BRAKE SPRING
C 31	● 228872	538228872	1	SEAL 13-32-5 (S7)	66	● 235075	538235075	1	LATCH PIVOT
B 32	● 241881	538241881	2	STUD BOLT	67	● 94006	538094006	1	BRAKE LATCH
33	235287	538235287	1	CLUTCH WASHER					
34	227259	538227259	1	WASHER					
35	235806	538235806	1	SCREW M5 X 20 TCE					

A= ALTA ROTAZIONE
 B=MEDIA ROTAZIONE
 C=BASSA ROTAZIONE

A=HIGH MOVING
 B=MEDIUM MOVING
 C=SLOW MOVING

A=HAUTE DEMANDE
 B=MOYENNE DEMANDE
 C=BASSE DEMANDE

A=GROBE NACHFRAGE
 B=MITTELMAEBIGE
 C=WENIGE NACHFRAGE