

brand	PARTNER - MC CULLOCH
-------	-----------------------------

date	NOV/02	SHEET 1/2
------	--------	-----------

Model

P 4546 SX
LM 4546 SX

Product number

9538781-24
9538783-36

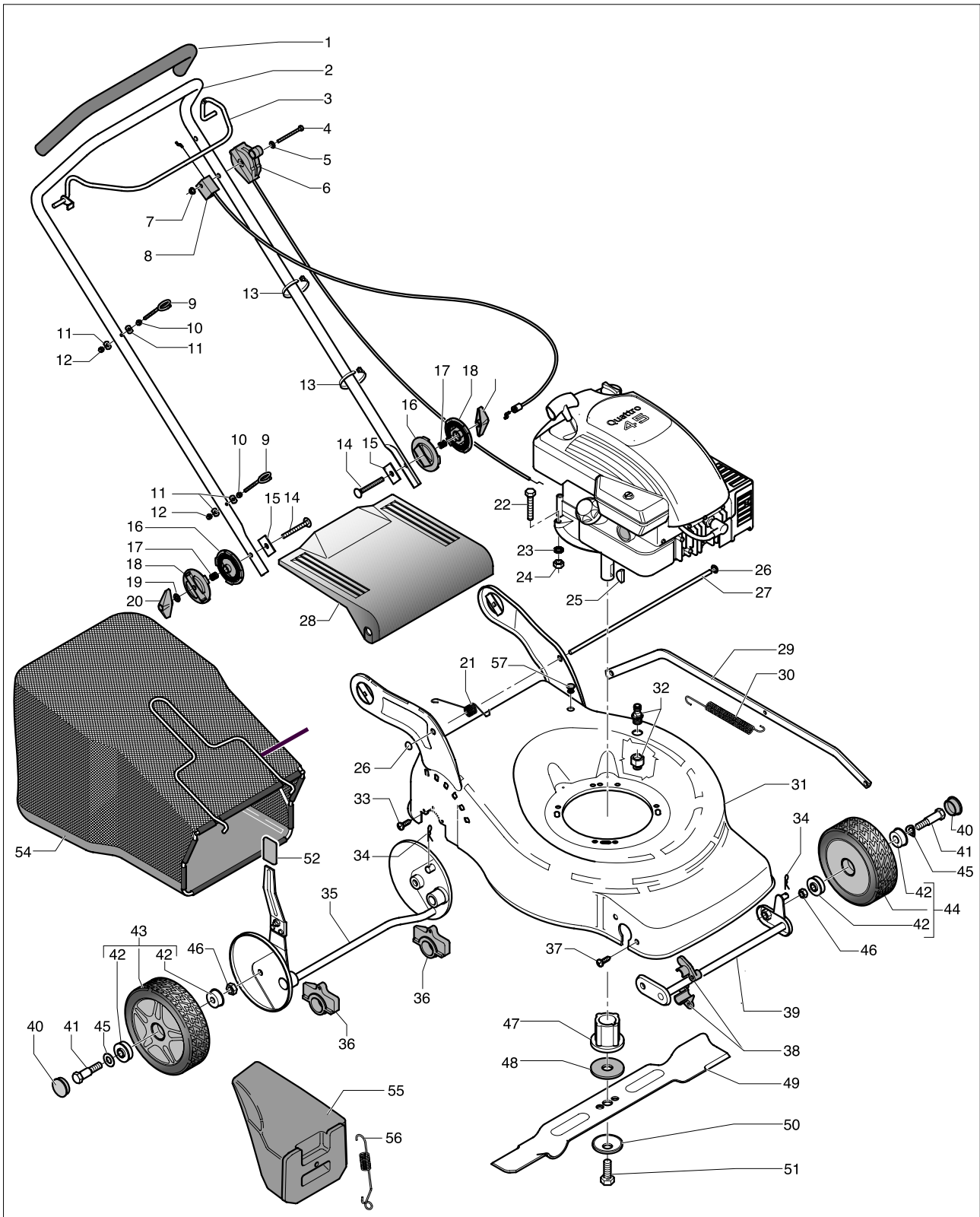

brand	PARTNER - MC CULLOCH
-------	-----------------------------

date	NOV/02	SHEET 2/2
------	--------	-----------

Model

P 4546 SX
LM 4546 SX

Product number

9538781-24
9538783-36

Pos	PN ELX	PN MEP	Q.ty	DESCRIPTION	Pos	PN ELX	PN MEP	Q.ty	DESCRIPTION
1	531205989	10146243	1	SHEATHING	46	531207978	20101700	4	NUT M10 H
2	531211438	10172933	1	HANDEL	47	531207242	10531600	1	BLADE SUPPORT
3	531211452	10135891	1	LEVER	48	531207243	10531700	1	WASHER 17,2x50x1,5+0,1
4	531206212	10155420	1	SCREW M5x60	49	531211017	10172770	1	BLADE
5	531206666	10284700	1	WASHER 5/15/1,5	50	531207237	10530900	1	WASHER 11x50x2,5
6	531206210	10155360	1	THROTTLE	51	531208008	20120580	1	SCREW 3/8
7	531205213	10121890	1	NUT M5	52	531207986	20107203	1	SHEATHING
8	531205191	10121610	1	BRAKE CABLE	53	531211436	10172913	1	SAC FRAMKE
9	531205169	10121470	2	CABLE HOOK	54	531211518	10173093	1	SAC (PARTNER)
10	531207165	10501200	2	NUT M6 H6	54	531211517	10173083	1	SAC (MAC CULLOCH)
11	531204961	10115900	4	WASHER 6,5E	55	531210617	10172700	1	MULCHING PLUG
12	531208491	20281800	2	NUT M6 H8	56	531211184	10172820	1	SPRING
13	531205581	10135600	1	CLAMP	57	531205153	10121353	1	PLUG
14	531211480	10173060	2	SCREW M8x55					
15	531211581	10173103	2	PLATE					
16	531211473	10173003	2	ADJUSTABLE DISK					
17	531211476	10173033	2	SPRING					
18	531211474	10173013	2	ADJUSTABLE DISK					
19	531204922	10114200	2	WASHER 8x16x1,5					
20	531211475	10173023	2	KNOP					
21	531205999	10146330	1	SPRING					
22	531205196	10121700	3	SCREW M8x35					
23	531207981	20106200	6	WASHER Ø8E					
24	531207982	20106300	3	NUT M8 H8					
25	531204907	10100900	1	KEY					
26	531210824	10175400	2	WASHER Ø8E					
27	531205060	10120530	1	TIE ROD					
28	531205982	10146211	1	DEFLECTORE					
29	531205069	10120653	1	ROD					
30	531205056	10120460	1	SPRING					
31	531211439	10172961	1	DECK					
32	531205848	10141313	1	COMPLETE CONNECTION					
33	531208216	20135720	2	SCREW Ø5x16					
34	531206653	10281400	2	COTTER PIN					
35	531205101	10121090	1	REAR AXLE					
36	531205944	10146093	2	SUPPORT					
37	531208844	20734900	4	SCREW 4,3x16					
38	531205057	10120473	4	SUPPORT					
39	531205051	10120290	1	FRONT AXELE					
40	531210538	10114801	4	PLUG					
41	531205042	10120090	4	SCREW					
42	531205214	10121900	8	BALL-BEARING					
43	531210613	09122041	2	WHEEL Ø190/26					
44	531210703	09175111	2	WHEEL Ø170/26					
45	531206644	10275100	4	WASHER B1					







PARTNER

Electrolux

4546 SX 4546 SDX 4646 SDXE



4546 SX

								
4546 SX	B&S Q4.5	46 cm	6/20-75 mm	53 l	29 kg	✓	-	-
4546 SDX	B&S Q4.5	46 cm	6/20-75 mm	53 l	29 kg	✓	✓	-
4546 SDXE	B&S Q4.5	46 cm	6/20-75 mm	53 l	29 kg	✓	✓	✓