

ILLUSTRATED PARTS BREAKDOWN

PARTNER

18.5 HP 46" LAWN TRACTOR

MODEL NO. P19-117EH (P185H46A)

954-12-00-29

REPAIR PARTS

TRACTOR- -MODEL NO. P19-117EH (P185H46A),

PRODUCT NO. 954 12 00-29

ELECTRICAL

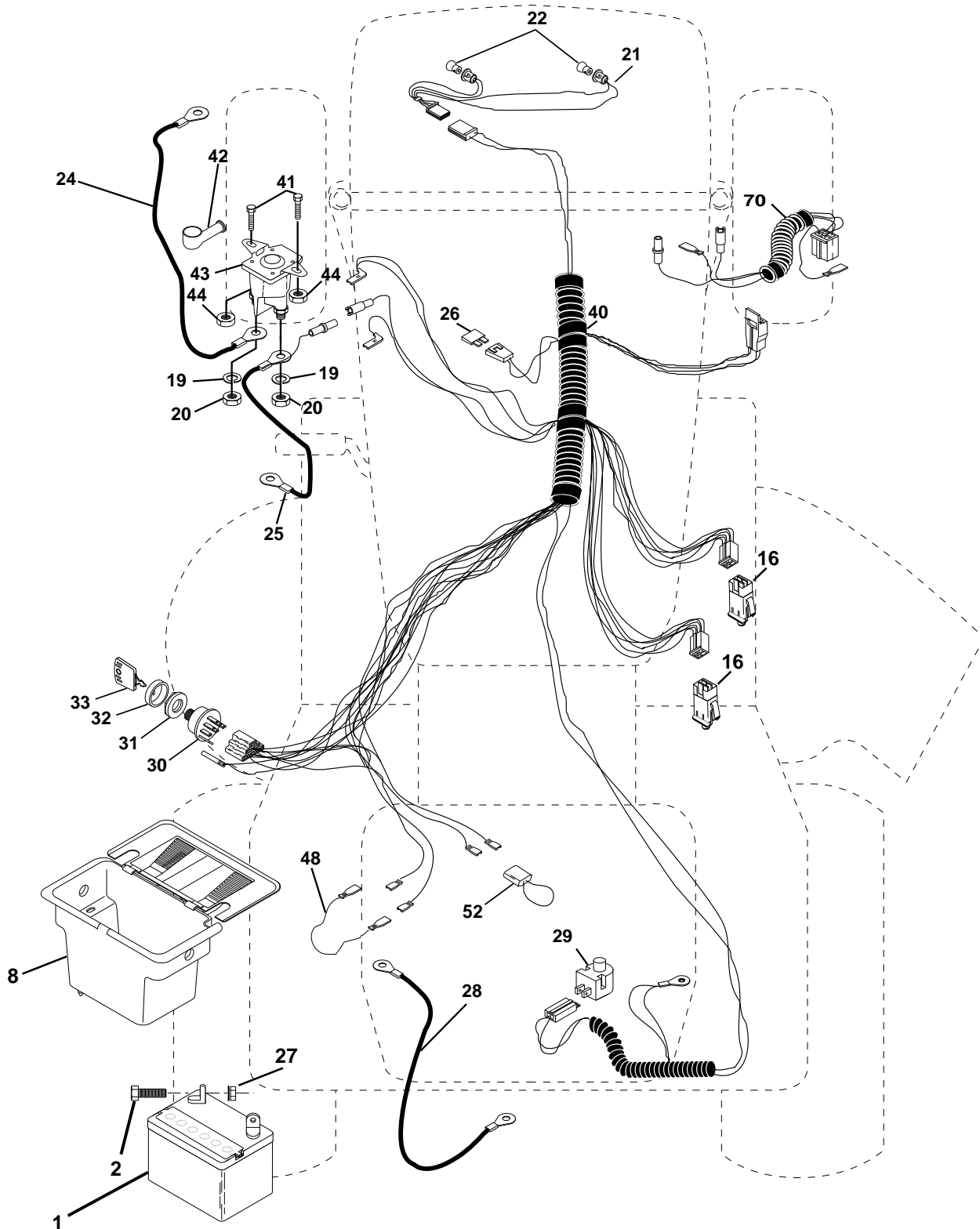

REPAIR PARTS

TRACTOR- -MODEL NO. P19-117EH (P185H46A),

PRODUCT NO. 954 12 00-29

ELECTRICAL

KEY NO.	PART NO.	DESCRIPTION
1	532144925	Battery 12 Volt 25 Amp
2	874760412	Bolt Hex Hd 1/4-20unc X 3/4
8	532156417	Case Battery
16	532153664	Switch Interlock Push -In
19	810090400	Washer Lock 1/4
20	873350400	Nut Jam Hex 1/4-20 Unc
21	532166181	Harness Asm Light W/4152J
22	532004152	Bulb Light #1156
24	532124780	Cable Battery 6 Ga 11"red
25	532146147	Cable Battery 6 Ga w/16 wire,red
26	532166180	Fuse 15 AMP
27	873510400	Nut Keps Hex 1/4-20 Unc
28	532124773	Cable Ground 6 Ga 12" black
29	532121305	Switch Plunger Nc Gray
30	532140301	Switch Ign 4 Position
31	532124211	Nut Ignition
32	532141226	Cover Sw Ignition
33	532122147	Key Ign
40	532166145	Harness Ign
41	871110408	Bolt Blk Fin Hex 1/4-20 X 1/2
42	532131563	Cover Terminal Red
43	532145673	Solenoid
44	873640400	Nut Keps Blk Hex 1/4-20 unc
48	532140844	Adapter Ammeter Rectangular
52	532141940	Protection Wire Loop
70	532166664	Harness Eng B&S Twin 9 am Re

NOTE: All component dimensions give in U.S. inches
1 inch = 25.4 mm.

REPAIR PARTS

TRACTOR- -MODEL NO. P19-117EH (P185H46A),

PRODUCT NO. 954 12 00-29

CHASSIS AND ENCLOSURES

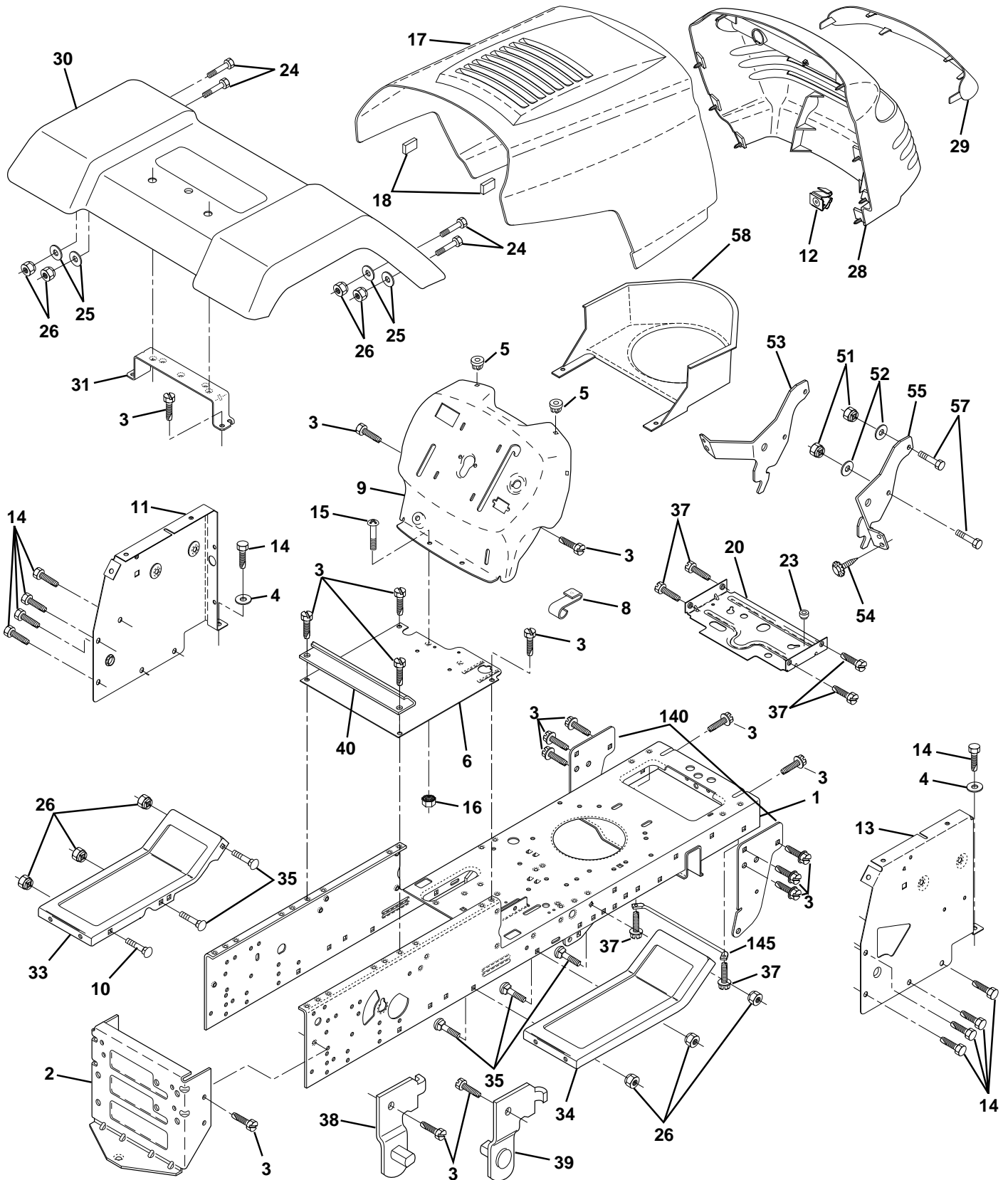

REPAIR PARTS

TRACTOR- -MODEL NO. P19-117EH (P185H46A),

PRODUCT NO. 954 12 00-29

CHASSIS AND ENCLOSURES

KEY PART NO.	NO.	DESCRIPTION
1	532165480	Chassis Lt Stamping 98
2	532140356	Drawbar Stretch 94
3	817490612	Screw Thdrol. 3/8-16 x 3/4 Ty-Tt
4	819131216	Washer 13/32 x 3/4 x 16 Ga.
5	532155272	Bumper Hood/Dash
6	532155923	Saddle Fender Shift Flat Lt
8	532155138	Clip Retainer Slide-On
9	532162717	Dash Private Label
10	872140608	Bolt RdHd Sqnk. 3/8-16 Unc x 1
11	532155927	Panel Asm. Dash Lh
12	532145660	Clip Tinnerman Grile P/L
13	532157262	Panel Dash Rh
14	817490608	Screw Thdrol. 3/8-16 x 1/2 Ty-Tt
15	874180512	Screw Mach Trhd 5/16-18 Unc x 3/4
16	873510500	Nut Keps 5/16-18 Unc
17	532160382	Hood Pnt Steel Private Label
18	532126938	Bumper Hood
20	532156437	Plate Mtg. Battery/Fuel Tank
23	532124028	Bushing Snap Nyl Blk Fuel Line
24	874780616	Bolt Fin Hex 3/8-16 Unc x 1 Gr. 5
25	819131312	Washer 13/32 x 13/16 x 12 Ga.
26	873800600	Nut Lock Hex w/Insert 3/8-16 UNC
28	532157375	Grill Private Lable Blk
29	532168154	Lens Grille Private label
30	532164048	Fender Asm
31	532139976	Bracket Fender
33	532147203	Footrest Pnt. Lh
34	532147202	Footrest Pnt. Rh
35	872110606	Bolt RdHd Sht. Sqnk. 3/8-16 x 3/4
37	817490508	Screw Thdrol 5/16-18 x 1/2
38	532139886	Bracket Asm. Pvt. Lh Mwr. Rear
39	532139887	Bracket Asm. Pvt. Rh Mwr. Rear
40	532139977	Spacer Fender Raised
51	873800400	Nut Lock Hex W/Ins. 1/4-20
52	819091416	Washer 9/32 x 7/8 x 16 Ga.
53	532144697	Bracket Grille LH
54	532161464	Screw Hex Wshd 8-18 x 7/8
55	532144696	Bracket, Grille RH
57	874780412	Bolt Fin Hex 1/4-20 x .75
58	532140547	Duct Air P/L B&S Opp Twin
140	532158418	Bracket Suspension Front
145	532156524	Rod Pivot Chassis/Hood
--	532005479	Plug Btn Blk

NOTE: All component dimensions given in U.S. inches
1 inch = 25.4 mm

REPAIR PARTS

TRACTOR- -MODEL NO. P19-117EH (P185H46A),

PRODUCT NO. 954 12 00-29

DRIVE

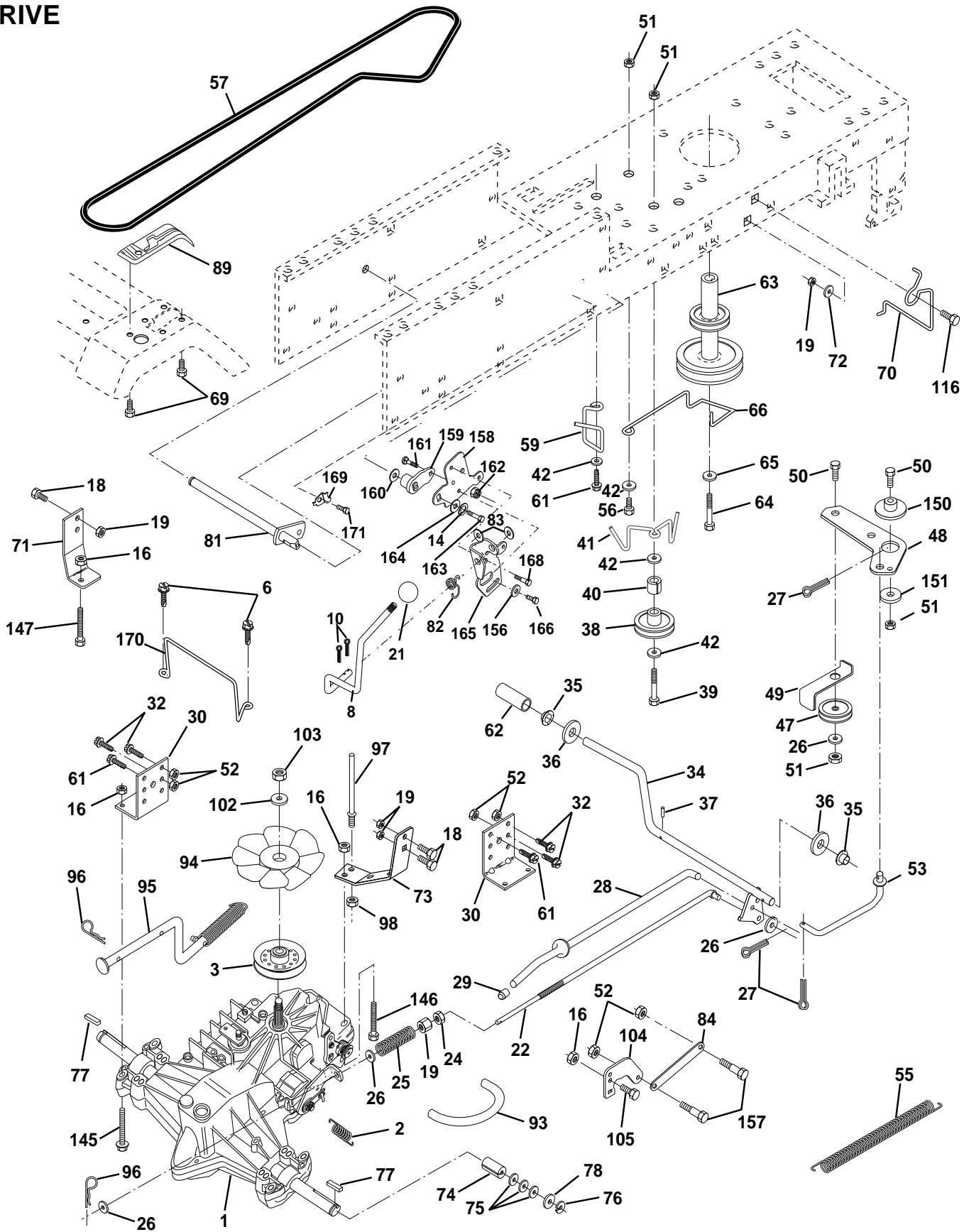

REPAIR PARTS

TRACTOR- -MODEL NO. P19-117EH (P185H46A),

PRODUCT NO. 954 12 00-29

DRIVE

KEY NO.	PART NO.	DESCRIPTION	KEY NO.	PART NO.	DESCRIPTION
1	-----	Transaxle Hydro Gear Model 319-0650 Order parts from Transaxle manufacturer.	66	532154778	Keeper Belt Engine
			69	532142432	Screw
2	532142431	Spring, Return, Brake	70	532156470	Keeper Belt Engine
3	532143995	Pulley, Transaxle	71	532140158	Strap Torque Lh Hydro
8	532165619	Rod Shaft Fender Adjust LT	72	819132012	Washer 13/32 x 1-1/4 x 12 Gauge
10	876020416	Pin Cotter 1/8 x 1 CAD	73	532156347	Strap Torque Rh Hydro
14	810040400	Washer Lock Hvy Helical	74	532121199	Spacer, Split
16	873800500	Nut Lock Hex W/Ins 5/16-18 Unc P	75	532121749	Washer 25/32 x 1-1/4 x 16 Gauge
18	874780616	Bolt Fin Hex 3/8-16 Unc x 1 Gr. 5	76	812000001	E-Ring
19	873800600	Nut Lock Hex W/Wsh 3/8-16 Unc	77	532123583	Key, Square
21	532140845	Knob Deluxe 1/2-13 Unc Blk/Blk	78	532121748	Washer 25/32 x 1-5/8 x 16 Gauge
22	532145627	Rod, Brake Hydro	81	532165591	Shaft Asm Cross Tapered 650 20
24	873350600	Nut	82	532123782	Spring Torsion T/A
25	532106888	Spring, Brake Rod	83	819171216	Washer 17/32 x 3/4 x 16 Ga.
26	819131316	Washer	84	532165815	Link Transaxle 0650 LT/YT/STL
27	876020412	Pin Cotter 1/8 x 3/4 CAD.	89	532166767	Console, Hydro
28	532145204	Rod, Parking Brake	93	532142564	Line Fuel Hydro 4"
29	532071673	Cap, Parking Brake	94	532140462	Fan, Hydro 7"
30	532130807	Bracket, Transaxle	95	532144643	Control Asm Bypass Hydro
32	874760512	Bolt Hex Hd 5/16-18 Unc x 3/4	96	532124788	Retainer Spring 1" Zinc/Cad
34	532155071	Shaft, Foot Pedal	97	532140469	Keeper Belt Rh Hydro 0750. 18/20"
35	532120183	Bearing, Nylon	98	873510600	Nut Keps Hex 3/8-16 Unc
36	819211616	Washer	102	532141322	Washer Belleville .501D x 1.50D
37	532124963	Pin, Roll	103	873940800	Nut, Hex, Jam Toplock 1/2-20 UNF
38	532131494	Pulley, Idler, Flat	105	871070516	Screw Cap Hex 5/16 x 18 x 1
39	874760644	Bolt	116	872110610	Bolt Rdhd Sq Neck 3/8-16 x 1.25
40	532124965	Spacer, Split	145	874490540	Bolt, Hex FLGHD 5/16-18 Gr. 5
41	532165838	Keeper, Belt Idler	146	874490536	Bolt Hex Flghd 5/16-18 x 2-1/4
42	819131312	Washer 13/32 x 13/16 x 12 Gauge	147	874490524	Bolt Hex Flghd 5/16-18 x 1-1/2
47	532127783	Pulley, Idler, V-Groove	150	532165850	Bushing Bellcrank Grd Drive
48	532154407	Bellcrank Clutch Grnd Drv STL	151	819133210	Washer 13/32 x 2 x 10 Ga.
49	532123205	Retainer, Belt	156	532166002	Washer Srrted 5/16 ID x 1 x .125
50	874760624	Bolt	157	532153236	Bolt Shoulder 5/16-18 Unc - 2A
51	873680600	Nut Crownlock 3/8-16 UNC	158	532165589	Bracket Shift Mount
52	873680500	Nut Crownlock 5/16-18 UNC	159	532165494	Hub Tapered Flange Shift LT
53	532105710	Link, Clutch	160	819292016	Washer 29/32 x 1-1/4 x 16 Ga
55	532105709	Spring, Return, Clutch	161	872140406	Bolt Rdhd Sqnk 1/4-20 x 3/4 Gr 5
56	874760620	Bolt Fin Hex 3/8-16 UNC x 1-1/4	162	873680400	Nut Crownlock 1/4-20 Unc
57	532140294	V-Belt, Ground Drive	163	874780416	Bolt Hex Fin 1/4-20 Unc x 1 Gr5
59	532140312	Keeper, Center Span	164	819091010	Washer 5/8 x .281 x 10 ga
61	817490612	Screw Thdrol. 3/8-16 x 3/4 Ty. TT	165	532165623	Bracket Pivot Lever
62	532124872	Cover, Pedal	166	532166880	Screw 5/16-18 x 5/8
63	532140186	Pulley, Engine	168	532165492	Bolt Shoulder 5/16-18 x .561
64	871170764	Bolt, Hex	169	532165581	Plate Fastening Lt
65	810040700	Washer	171	817490608	Screw Thdrol 3/8-16 x 1/2 Ty-Tt

NOTE: All component dimensions given in U.S. inches
1 inch = 25.4 mm

REPAIR PARTS

TRACTOR- -MODEL NO. P19-117EH (P185H46A),

PRODUCT NO. 954 12 00-29

STEERING ASSEMBLY

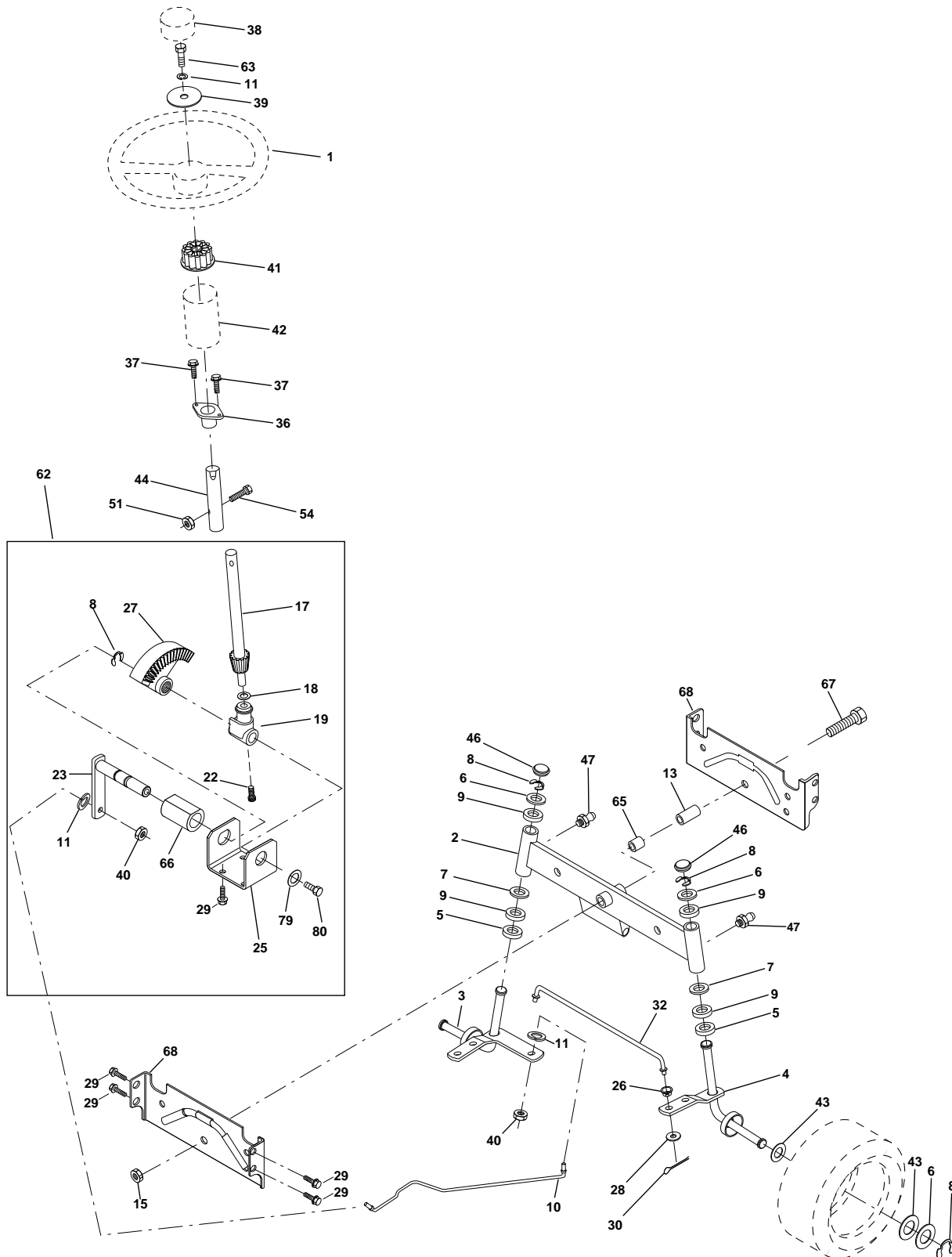

REPAIR PARTS

TRACTOR- -MODEL NO. P19-117EH (P185H46A),

PRODUCT NO. 954 12 00-29

STEERING ASSEMBLY

KEY NO.	PART NO.	DESCRIPTION
1	532139768	Wheel Steering
2	532154427	Axle Asm Front
3	532156483	Spindle Asm Lh
4	532157473	Spindle Asm Rh
5	532124931	Bearing Race Thrust Harden
6	532121748	Washer 25/32 X 1 5/8 X 16ga
7	819272016	Washer 27/32 X 1 1/4 X 16 Ga
8	812000029	Ring Klip #t5304-75
9	532124937	Bearing Col Strg Blk
10	532156438	Link Drag Extended
11	810040600	Lockwasher
13	532154779	Spacer Bearing Axle Front
15	873901000	Locknut Flange 5/8-11 Unc
17	532156546	Shaft Asm Strg
18	532057079	Washer Thrust 515x 750x 033
19	532160395	Support Shaft
22	532165857	Screw Hex Wshhd Torx
23	532165851	Shaft Asm Pittman
25	532154406	Bracket Steering
26	532126847	Bushing Rod Tie Blk Lt
27	532136874	Gear Sector
28	819131416	Washer 13/32 X 7/8 X 16ga
29	817490612	Screw Thdrol 3/8-16x3/4 Ty-tt
30	876020412	Pin
32	532130465	Rod Tie Wire Form 19 75 Mech
36	532155099	Bushing Strg 5/8 Id Dash
37	532152927	Screw TT #10-32 x 5 x 3/8 Flange
38	532140175	Insert Cap Strg
39	819133808	Washer 13/32 X 2-3/8 X 8 Ga
40	532124701	Locknut Center
41	532100711	Adaptor Wheel Strg
42	532145054	Boot Shaft Steering
43	532121749	Washer 25/32 X 1 1/4 X 16 Ga
44	532153720	Extension Steering Non-Adjust
46	532121232	Cap Spindle Fr Top Blk
47	532124836	Fitting Grease
51	873800500	Nut Lock Hex w/Ins 5/16-18 Unc
54	874780520	Bolt Fin Hex 5/16-18 Unc x 1-1/4
62	532167902	Kit Steering Assembly Service
63	874780616	Bolt Fin Hex 3/8-16 Unc x 1 Gr. 5
65	532154780	Spacer Axle
66	532154404	Bearing Arm Pittman
67	874781044	Bolt Fin Hex 5/8-11 UNC x 2-3/4
68	532154429	Brace Axle
79	819132012	Washer 13/32 x 1-1/4 x 12 Ga
80	874950612	Bolt Hex Nylon 3/8-16 x 3/4

NOTE: All component dimensions give in U.S. inches
1 inch = 25.4 mm.

REPAIR PARTS

TRACTOR- -MODEL NO. P19-117EH (P185H46A),

PRODUCT NO. 954 12 00-29

SEAT ASSEMBLY

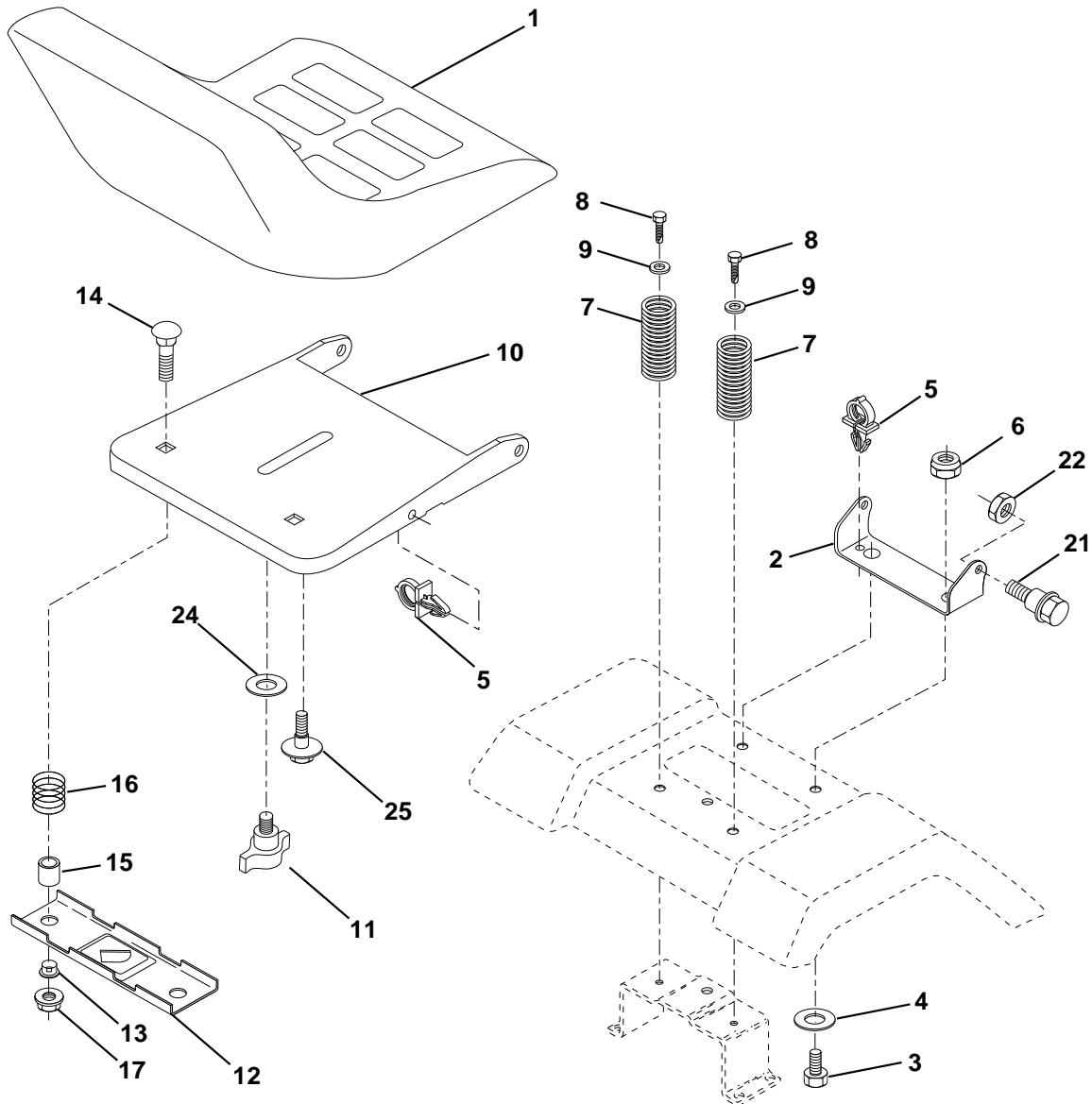

KEY NO.	PART NO.	DESCRIPTION
1	532140118	Seat
2	532140551	Bracket Pnt Pivot Seat (blk)
3	874760616	Bolt
4	819131610	Washer 13/32 X 1 X 10 Ga
5	532145006	Clip Push-In Hinged
6	873800600	Nut
7	532124181	Spring Seat Cprsn 2 250 Blk Zi
8	817490616	Screw Thdrol 3/8-16 X 1 Ty-tt
9	819131614	Washer 13/32 X 1 X 14 Ga
10	532155925	Pan Pnt Seat (blk)
11	532166369	Knob Seat Adj Wingnut
12	532121246	Bracket Pnt Mounting Switch

KEY NO.	PART NO.	DESCRIPTION
13	532121248	Bushing Snap Blk Nyl 50 Id
14	872050412	Bolt Rdhd Sht Nk 1/4-20x1-1/2
15	532121249	Spacer Split 28 X 88 Yel Zinc
16	532123740	Spring Cprsn
17	532123976	Nut Lock 1/4 Lge Flg Gr 5 Zinc
21	532153236	Bolt Shoulder 5/16-18 Unc Blkz-2A
22	873800500	Nut
24	819171912	Washer 17/32 X 1-3/16 X 12 Ga
25	532127018	Bolt Shoulder 5/16-18 X 62

NOTE: All component dimensions given in U.S. inches
1 inch = 25.4 mm

REPAIR PARTS

TRACTOR- -MODEL NO. P19-117EH (P185H46A),

PRODUCT NO. 954 12 00-29

DECALS

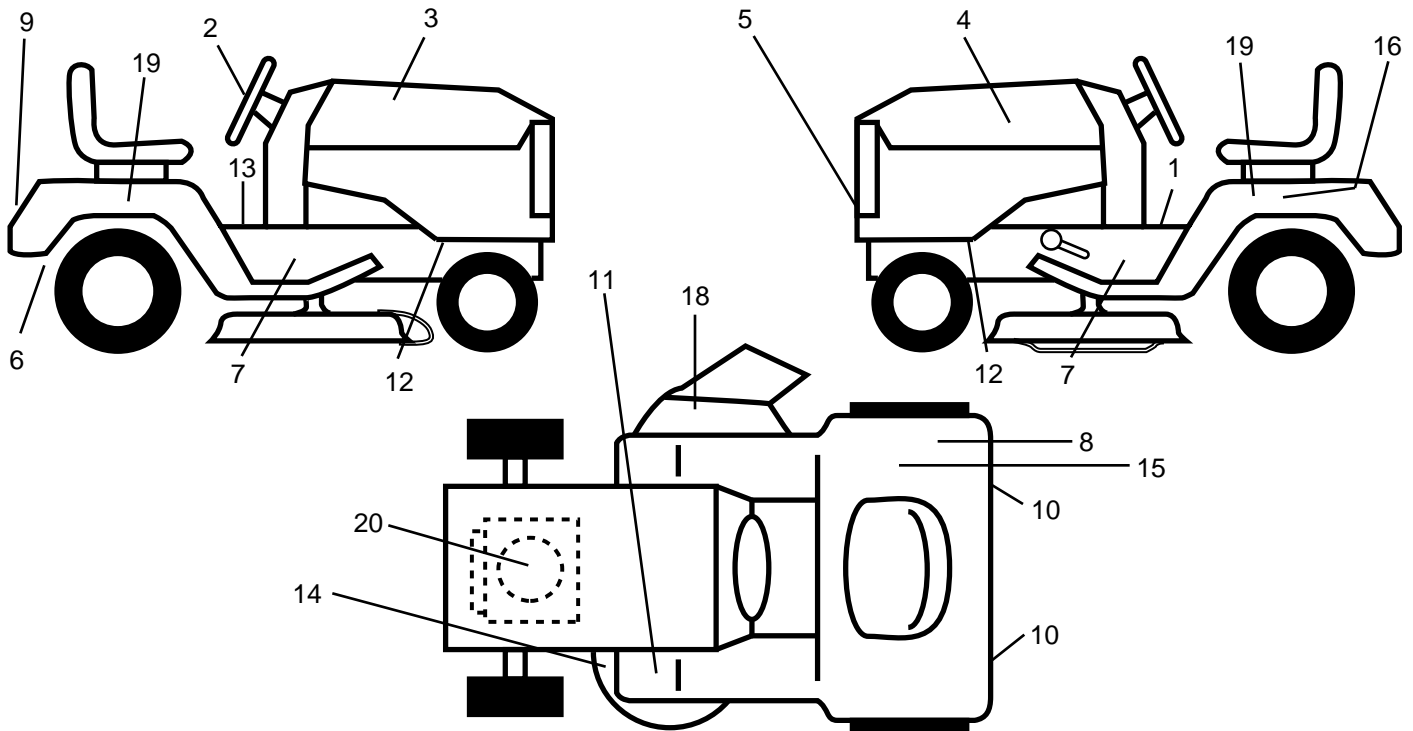

KEY NO.	PART NO.	DESCRIPTION
1	532145498	Decal Read Owners Manual
2	532146998	Decal Ins Strg Wh
3	532166753	Decal Hood Rh
4	532166754	Decal Hood Lh
5	532140986	Decal Grille Lens
6	532142341	Decal Drawbar Cntrl Mvt Hyd Lt
7	532137588	Decal Chas Turbo Collection Lt
8	532126187	Decal 100 DBA
9	532140987	Decal Fender Logo
10	532106202	Reflector Tailgate Red/Amber
11	532159737	Decal Clutch/brake
12	532159736	Decal Chassis Hot Muffler

KEY NO.	PART NO.	DESCRIPTION
13	532140837	Decal Saddle Brake Parking
14	532139346	Decal V-belt Schematic
15	532145437	Decal Europe Stand CE
16	532145005	Decal Battery Danger/Poison
18	532145494	Mower Cut Finger
19	532140950	Decal Fender Automatic Partner
20	532165358	Decal HP Engine
--	532162598	Decal Drawbar Load Limit
--	532138311	Decal Lift Handle
--	532157199	Pad Footrest
--	532166478	Manual Operators Euro
--	532166484	Manual Operators Scan

WHEELS & TIRES

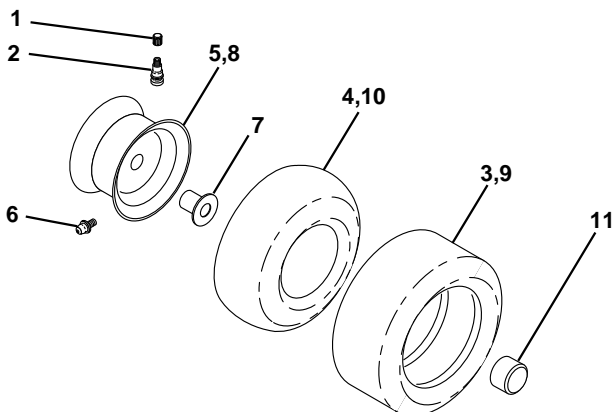

KEY NO.	PART NO.	DESCRIPTION
1	532059192	Cap Valve Tire
2	532065139	Stem Valve
3	532106222	Tire F Ts 15 x 6 0 - 6 Service
4	532059904	Tube Front (Service Item Only)
5	532125121	Rim Asm 6" front Service
6	532124957	Fitting Grease (Front Wheel Only)
7	532124959	Bearing Flange (Front Wheel Only)
8	532125122	Rim Asm 8" rear Service
9	532122082	Tire R Ts 20 x 10-8 C Service
10	532124926	Tube Rear (Service Item Only)
11	532104757	Cap Axle Blk 1 50 x 1 00
--	532144334	Sealant, Tire (10 oz. Tube)

NOTE: All component dimensions given in U.S. inches
1 inch = 25.4 mm

REPAIR PARTS

TRACTOR- -MODEL NO. P19-117EH (P185H46A),

PRODUCT NO. 954 12 00-29

ENGINE

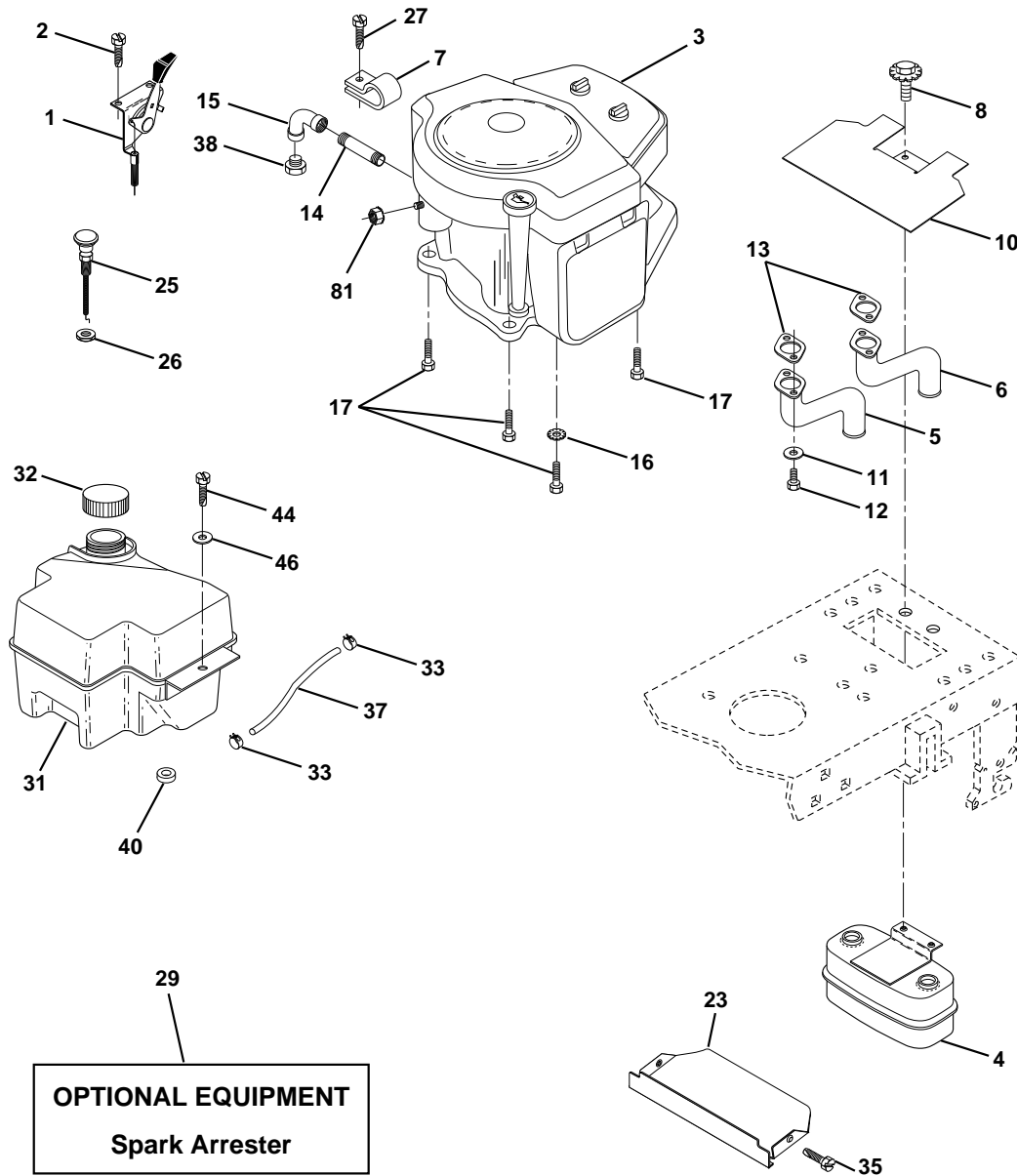

KEY NO.	PART NO.	DESCRIPTION
1	532141295	Control Throt 35.5 Lh Flag
2	817720410	Screw Hex Thd Cut 1/4-20x5/8 T
3	-----	Engine B&S Model 42A777 Order parts from engine manufacturer.
4	532149723	Muffler Exhaust
5	532144069	Exhaust Asm. Left
6	532144068	Exhaust Asm. Right
7	532138129	Clamp Tube Double Engine
8	532150176	Bolt 5/16-18unc x 3/4 w/sems
10	532145552	Shield Heat
11	810040400	Washer Lock Hvy Helical
12	874780412	Bolt Fin Hex 1/4-20 Unc x .75
13	532165287	Gasket Muffler
14	813280336	Nipple Pipe 4-1/2"
15	813200300	Elbow Std 90 Degree 3/8-18 Npt
16	811050600	Washer Lock Ext Tooth 3/8
17	817490624	Screw Thdrol 3/8-16x1-1/2 Tytt

KEY NO.	PART NO.	DESCRIPTION
23	532159880	Shield Brn/Dbr Guard
25	532145996	Control Choke
26	873920600	Nut Keps 3/8-24 UNF
27	532152927	Screw TT #10-32.5 3/8 Flange
29	532137180	Arrestor Spark
31	532161911	Tank Fuel Front 2.00
32	532140527	Cap Fuel
33	532123487	Clamp Hose Blk
35	817490512	Screw Thdrol 5/16-18 x 3/4
37	532137040	Line Fuel
38	-----	Plug Oil Drain (Order From Engine Manufacturer)
40	532124028	Bushing
44	817490412	Screw Hex wsh Thdrol 1/4-20 x 3/4
46	819091416	Washer 9/32 x 7/8 x 16 Ga.
81	532128861	Nut Flange 1/4-20 Starter Nut

NOTE: All component dimensions given in U.S. inches
1 inch = 25.4 mm

REPAIR PARTS

TRACTOR- -MODEL NO. P19-117EH (P185H46A),

PRODUCT NO. 954 12 00-29

MOWER LIFT

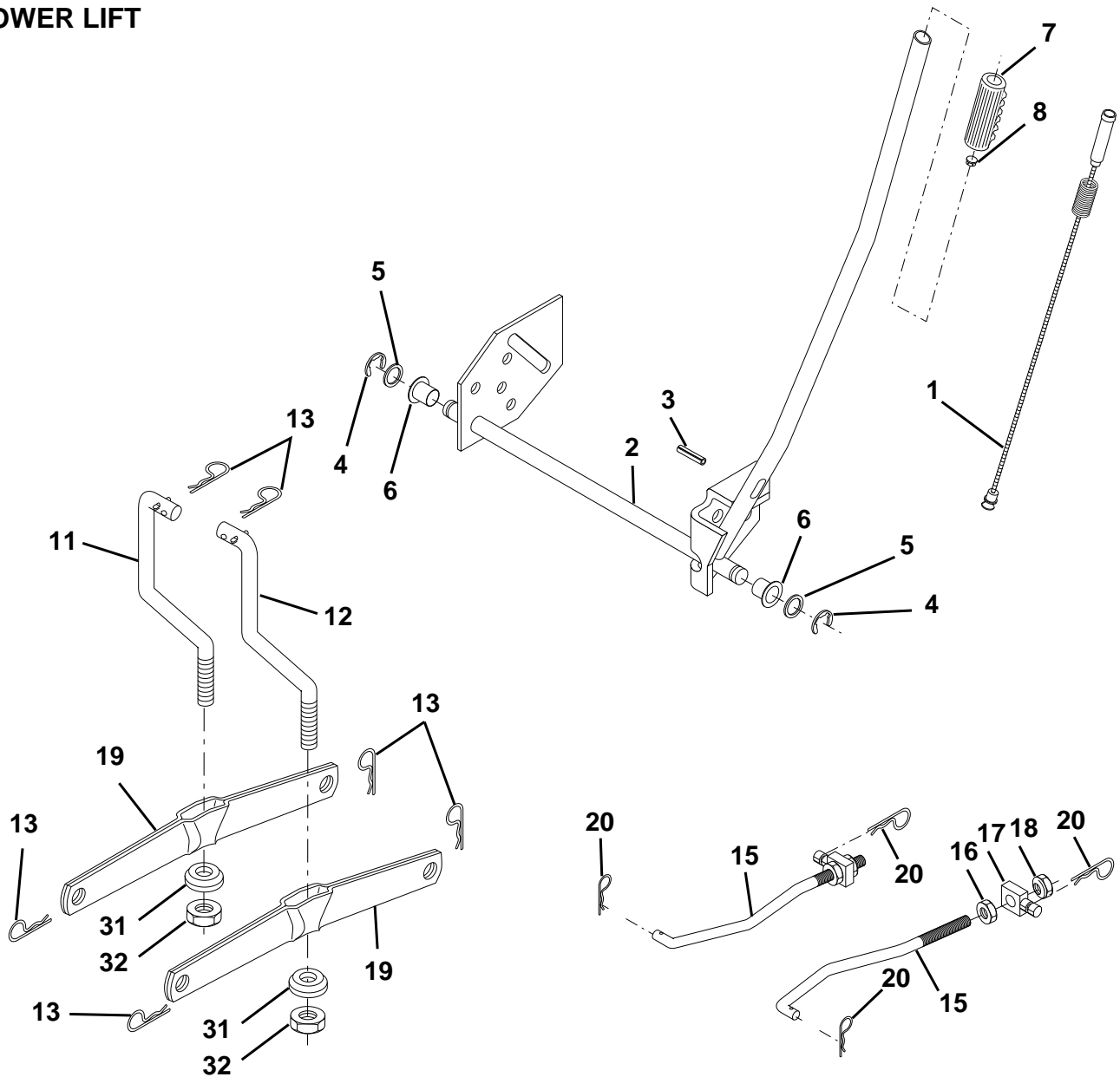

KEY NO.	PART NO.	DESCRIPTION
1	532159460	Wire Asm Inner/Spring w/Plngr Lt
2	532159471	Shaft Asm Lift
3	532105767	Pin Groove
4	812000002	E Ring #5133-62
5	819211621	Washer 21/32 x 1 x 21 Ga.
6	532120183	Bearing Nylon
7	532109413	Grip Handle
8	532124526	Button Plunger
11	532139865	Link Lift Lh
12	532139866	Link Lift Rh
13	532124670	Retainer Spring

KEY NO.	PART NO.	DESCRIPTION
15	532127218	Link Front
16	873350800	Nut Jam Hex 1/2-13 Unc
17	532130171	Trunnion Blk Zinc
18	873680800	Nut Crownlock 1/2-13 Unc
19	532139868	Arm Suspension Rear
20	532163552	Retainer Spring
31	532140302	Bearing Pvt Lift Spherical
32	873540600	Nut Crownlock 3/8-24

NOTE: All component dimensions given in U.S. inches
1 inch = 25.4 mm

REPAIR PARTS

TRACTOR- -MODEL NO. P19-117EH (P185H46A),

PRODUCT NO. 954 12 00-29

MOWER DECK

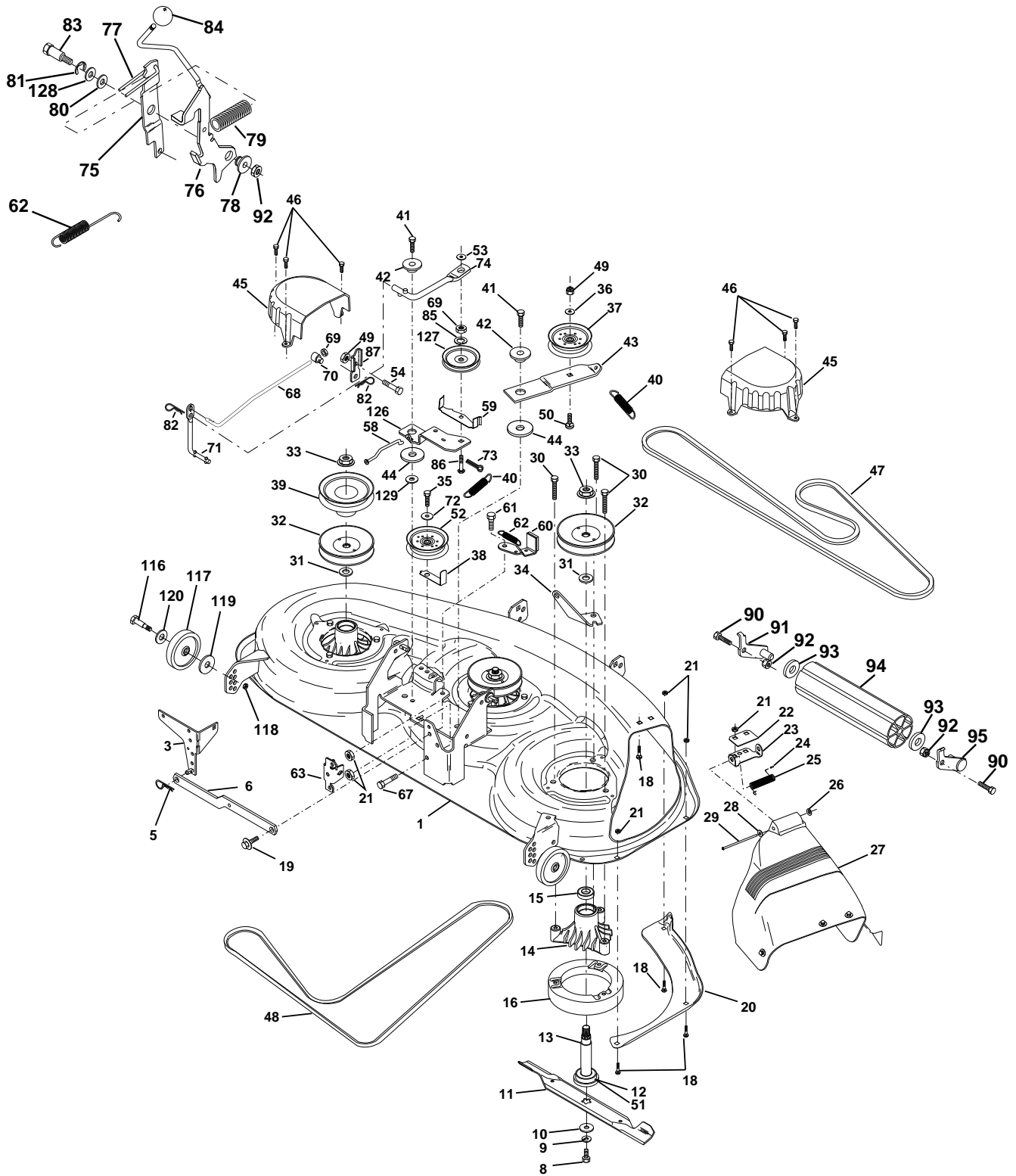

REPAIR PARTS

TRACTOR- -MODEL NO. P19-117EH (P185H46A),

PRODUCT NO. 954 12 00-29

MOWER DECK

KEY NO.	PART NO.	DESCRIPTION	KEY NO.	PART NO.	DESCRIPTION
1	532156948	Deck Asm., Mower 46"	52	532156493	Pulley Idler
3	532138457	Bracket Asm., Sway Bar	53	819131312	Washer 13/32 x 13/16 x 12 Ga.
5	532124670	Retainer Spring	58	532156488	Link Brake 46"
6	532130832	Arm, Suspension, Rear (Sway Bar)	59	532157034	Guide Belt 46"
8	532850857	Bolt, Patched 3/8-24 x 1-1/4 Gr. 8	60	532156722	Arm Asm Brake
9	810030600	Washer, Lock Hvy., Unplated 3/8	61	532161315	Bolt Shld 5/16-18 Ty TT
10	532140296	Washer, Hard Blade, Mower Vented	62	532131870	Spring Return
11	532157033	Blade, 46" Mower Deck	63	532156473	Bracket Clutch Rod Pivot
12	532129895	Bearing, Ball, Mandrel #6204	67	874760512	Bolt Hex Hd 5/16-18 UNC x 3/4
13	532137553	Shaft Asm. w/Lower Bearing (Includes Key No. 12)	68	532156487	Rod Clutch
14	532137152	Housing, Mandrel	69	873350600	Nut Hex Jam 3/8-16 UNC
15	532110485	Bearing, Ball, Mandrel	70	532142028	Trunnion Adj
16	532140329	Stripper, Mower Round	71	532133551	Rod Pivot w/Nibs
18	872140505	Bolt, Carriage 5/16-18 x 5/8	72	819131316	Washer 13/32 x 13/16 x 16 Ga.
19	532132827	Bolt, Hex Head, Shoulder 5/16-18	73	876020412	Pin Cotter 1/8 x 3/4
20	532145055	Baffle, Vortex Mower 46"	74	532156474	Link Clutch 46"
21	873680500	Nut, Crownlock 5/16-18 UNC	75	532127847	Arm Clutch Secondary
22	532134753	Stiffener, Bracket	76	532160570	Lever Asm. Clutch Pri Plm Stlt
23	532131267	Bracket, Deflector	77	532127845	Keeper Spring
24	532105304	Cap, Sleeve	78	532127498	Bushing .747 O.D. x .794 Lg Brass
25	532149287	Spring, Torsion, Deflector	79	532153701	Spring Mower Clutch
26	532110452	Nut, Push	80	532121748	Washer 25/32 x 1-5/8 x 16 Ga.
27	532157788	Shield, Deflector Mower	81	812000029	Ring Klip
28	819111016	Washer 11/32 x 5/8 x 16 Ga.	82	532124788	Retainer Spring 1"
29	532131491	Rod, Hinge	83	532128903	Bolt Shoulder 3/8-16 UNC
30	532157722	Screw Thd Rolling Washer Head	84	532162132	Knob Rd 7/16-14 Plstc Thds
31	532129963	Washer, Spacer Mower Vented	85	810040600	Washer Lock Hvy Hlcl Spr. 3/8
32	532153531	Pulley, Mandrel	86	532158565	Bolt Carr Sh 3/8-16 x 2 Gr. 5
33	532137266	Nut, Flg. Top Lock Cntr. 9/16	87	532158373	Bracket Extension
34	532144945	Anchor, Spring Deck 46"	88	874780616	Bolt Fin Hex 3/8-16 UNC x 1 Gr. 5
35	817490628	Screw, Thdroll 3/8-16 x 1-3/4 Tytt	90	874760616	Bolt Fin Hex 3/8-16 x 1
36	819131316	Washer 13/32 x 13/16 x 16 Ga.	91	532132274	Bracket Asm Noseroller Lh
37	532131494	Pulley, Idler, Flat	92	873800600	Nut Lock Hex w/ Ins 3/8-16 UNC
38	532156086	Keeper, Belt, Idler	93	819171416	Washer 17/32 x 7/8 x 16 Ga.
39	532144917	Pulley, Idler, Driven	94	532132264	Roller Nose 38/42
40	532137273	Spring, Secondary 44/46/50 Vent	95	532132273	Bracket Asm Noseroller Rh
41	817490620	Screw, Thdroll 3/8-16 x 1-1/4 Tytt	116	532124842	Bolt, Shoulder
42	532122052	Spacer, Retainer	117	532105455	Gauge Wheel, Narrow
43	532144949	Arm, Idler Secondary	118	873930600	Nut, Centerlock 3/8-16 UNC
44	532133943	Washer, Hardened	119	819121414	Washer 3/8 x 7/8 x 14 Ga.
45	532145059	Cover, Mandrel Deck	120	819171512	Washer 17/32 x 15/16 x 12 Ga.
46	532137729	Screw, Thdroll. 1/4-20 x 5/8	126	532156472	Arm, Idler, Primary Deck 46"
47	532144959	V-Belt, Mower, Secondary	127	532146763	Pulley, Idler, V-Groove Dim. 4.25
48	532158818	V-Belt, Mower, Primary	128	532124931	Washer Thrust .75 x 1.230
49	873680600	Nut, Crownlock 3/8-16 UNC	129	819133808	Washer 13.32 x 2-3/8 x 8 Ga.
50	872110612	Bolt, Carriage 3/8-16 x 1-1/2 Gr. 5	--	532157162	Deck Complete (Std. Deck-Order separately gauge wheel components Key Nos. 116-118)
51	532153390	Washer Felt	--	532143651	Mandrel Asm Service

NOTE: All component dimensions given in U.S. inches
1 inch = 25.4 mm